

POOL STEPS

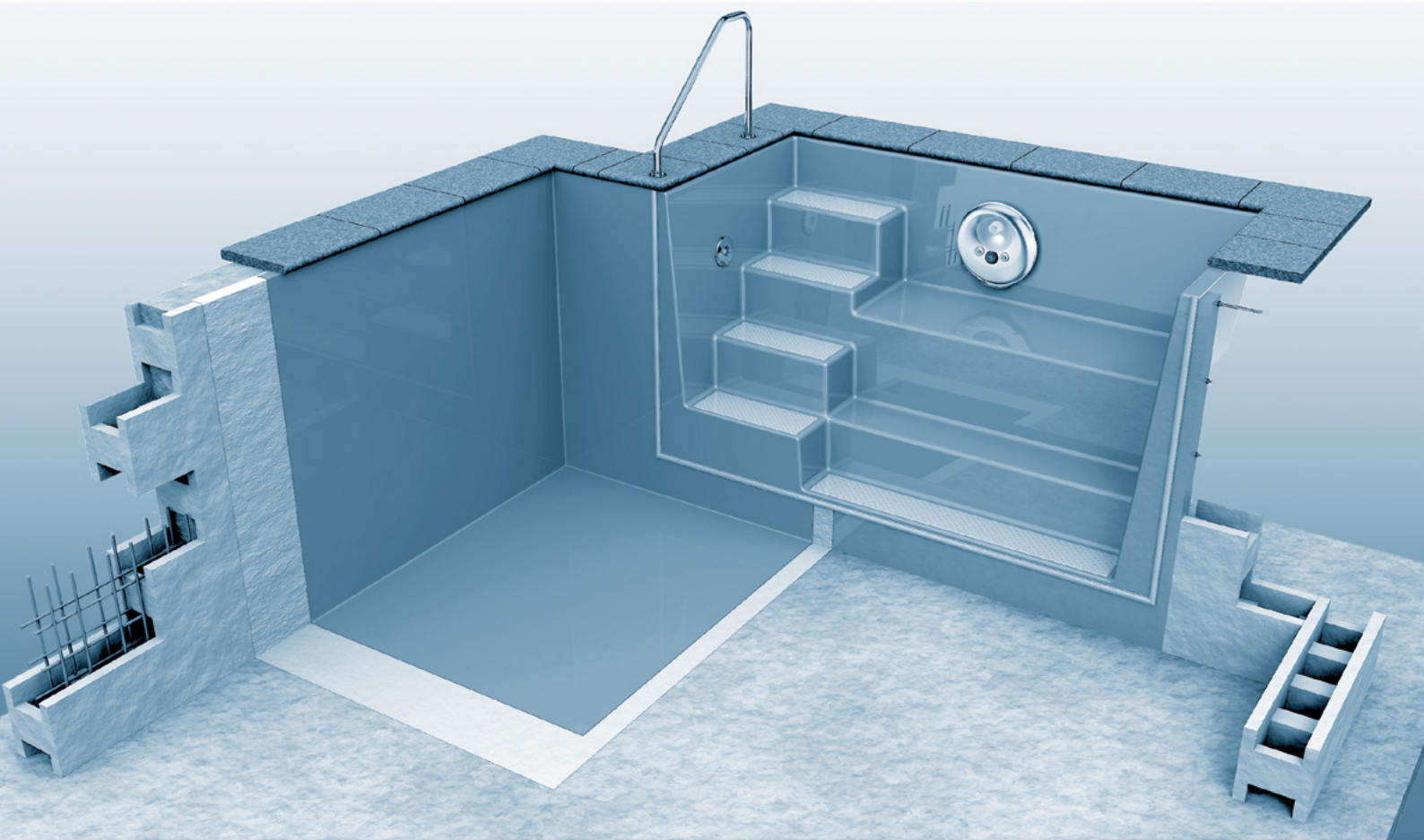

Pricelist 2021

Sales Prices in Euro excl. VAT. Valid from 01.01. – 31.12.2021

REKU
Composite-Pools



COLOUR SURVEY



Eleganz 80 "U", short version
Colour granite with step treads in silver grey and universal grabrail "above water level" and grabrail "below water level" for Eleganz 80

WHITE
Alkorplan White 90057
DLW delifol NG White
Elbtal White 104

SAND
Alkorplan Sand 91669
DLW delifol NG Sand
Elbtal Sand 151

SEA BLUE
Alkorplan lightblue 50001
DLW delifol NG azur
Elbtal lightblue 602

SILVER GREY
Alkorplan grey 70981
DLW delifol NG grau
Elbtal grey 765

AZURE BLUE
Alkorplan adriatic blue 52341
DLW delifol NG blau
Elbtal adriatic blue 604

GRANITE
Alkorplan dark grey
DLW delifol NG Granite
Elbtal dark grey 782

Samples available on request

We recommend to use step treads in the colour of the liner and the step itself in contrasted colour to the liner (for example liner and step treads in azure blue and the step in white or liner and step treads in silver grey and the step in granite). In that way slight colour differences that occur between the different liner manufacturers can be equalised.

NOTE: Every surface colour loses intensity over time, due to weathering, UV radiation, influences of water chemistry etc. This is a normal process, but it is more visible with dark colours than with light colours. These colour differences are hardly or not at all visible when the pool is full - at most in the area of the air-water edge.

When the pool is empty, however, these appear. These colour differences do not affect the life or durability of the pool in any way and they are not reason for complaint. See also DIN 16582-1 2015 Appendix D "Aesthetic aspects of one-piece GRP pools".

1 WELL DESIGNED



High gloss surface from Duracolor 3000 smooth and soft to the touch.



Step treads as an option in a different colour.

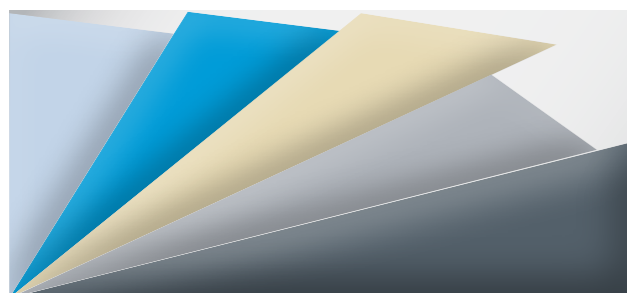

Colour options to match the PVC liner ranges.

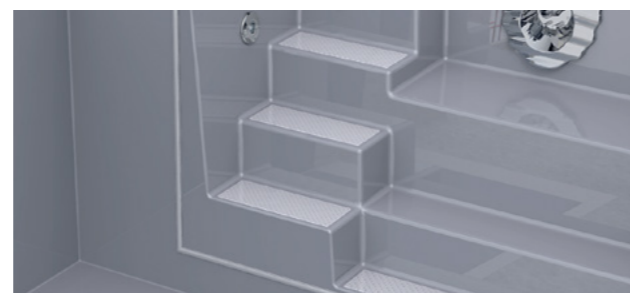

Cover liner clamp plate to match the colour of the PVC-liner.

3 FUN & FUNCTION



Integrated seat.



Matching grabrails.



All treads with certified anti-slip profiled surface..



Jet- and massage systems available.

2 PERFECT STABILITY

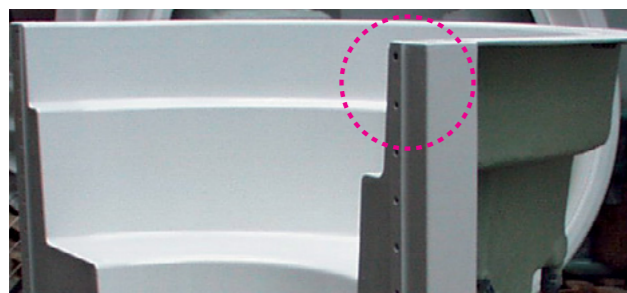

Proper flanges guarantee easy installation and alignment.



PVC liner can be fixed with a clamp plate or glued/ welded on a PVC strip.



Extremely strong due to several layers of carbon composite plus additional strengtheners.

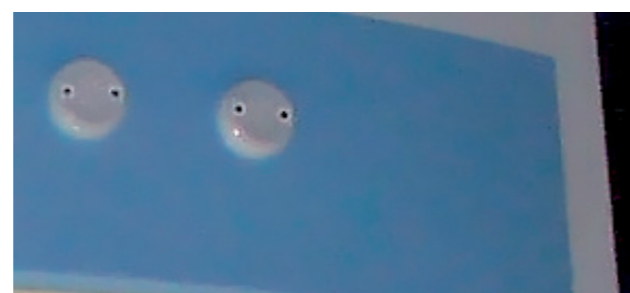

Alternatively: PVC-strip for welding of 1,5 mm liner.

4 EASY INSTALLATION

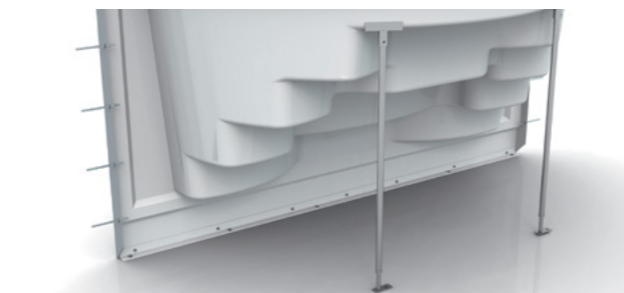

Adjustable supporting posts for easy alignment.



Step-ends matching Reku coping stones..



Step-end comes on a pallet incl. mounting instruction and fixing kit..

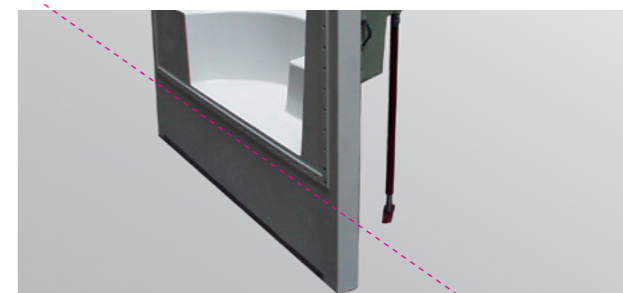

Step-ends can be cut to requested height on site.

PRICING:

Prices in this list only apply to orders received by us up to the 31st of December. The listed price valid on the day of delivery is invoiced if the goods are collected later. The price stands in Euro excl. VAT.

TRANSPORTATION COSTS:

Freight charges: upon request. Special costs, customs and bordercosts, ferries etc., are paid by the customer.

INSTALLATION COSTS:

Prices for on-site installation are not included in this price list, as these services are carried out by a specialised company and invoiced separately.

WARRANTY:

Reku CP-Elements and pools and their equipment and accessories are designed to be used for swimming and bathing. The pools must be filled with water from the mains.

The water needs to be of drinking water quality. Mineral water, water with a high salt content and spring water are not suitable. The maximum metal content should not be higher than the following values.

▪ Iron	0,1 mg	per Liter
▪ Manganese	0,05 mg	per Liter
▪ Ammonium	2,0 mg	per Liter
▪ Polyphosphat	0,005 mg	per Liter
▪ Copper	0,01 mg	per Liter
▪ Chloride	300 mg	per Liter
	(with use of electrical heater 150 mg/l)	

Higher values can cause corrosion of the equipment and parts or cause deposits on the pool walls. The maximum water temperature for pools is 32° C. The installation should only be carried out by a professional swimming pool builder.

SHIPPING:

Single load

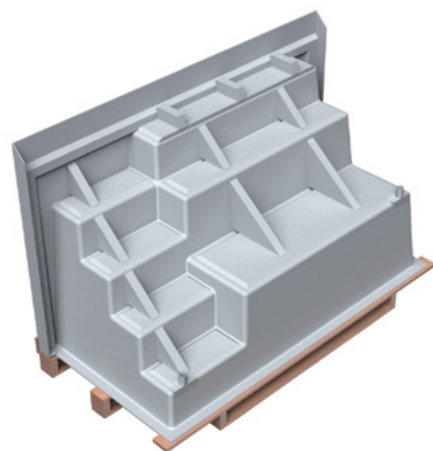

Double load

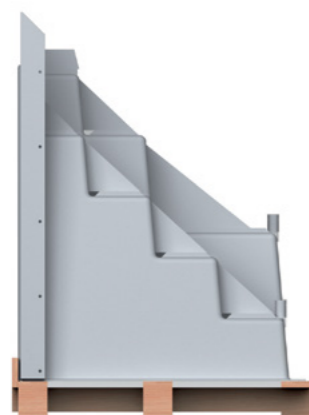

Step-end ideal for New Liner pools under construction „N“

With clamp plate to fix the pool liner. Installation between pool walls with concrete backfilling.

All 8 models are with clamp plate or with PVC welding strip available!

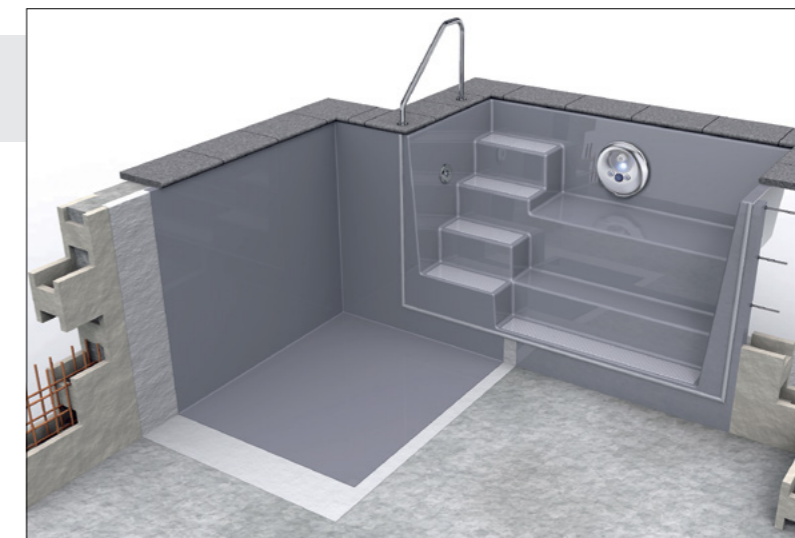

Step-end ideal for New Liner pools under construction or for renovation „N+S“

With PVC strip to weld a 1,5 mm thick liner on. Installation in pool corners – backfilling unnecessary.

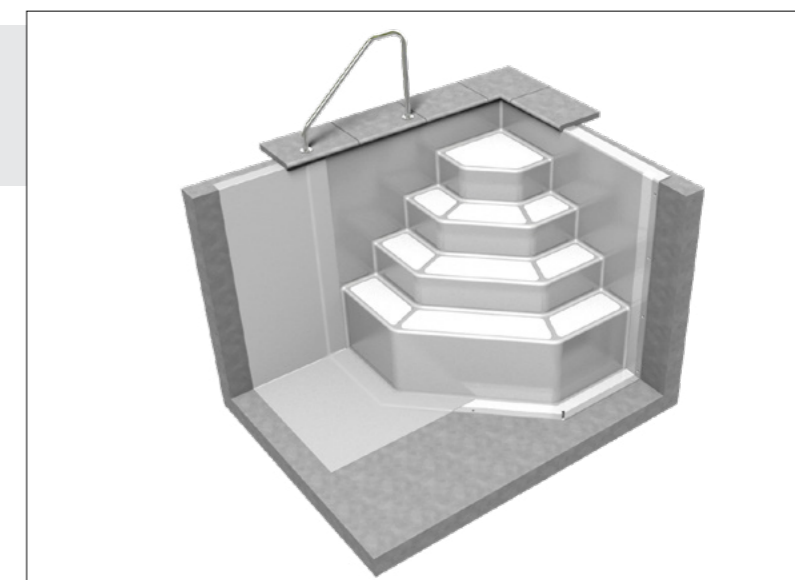

Step-end ideal for all kinds of pools installed in the pool „U“

Suitable for liner, tiles, metal or GRP.

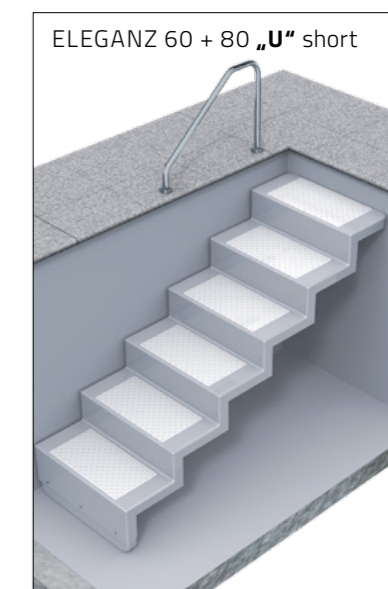
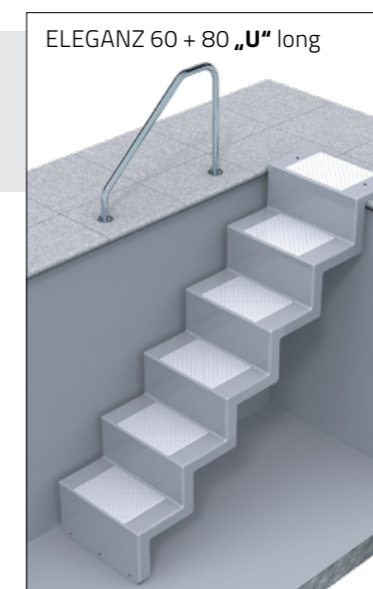

ON THE FOLLOWING PAGES WE HAVE MARKED:

- 8 step-ends designed for new build liner pools marked as "N" (New Liner pools).
- 3 step-ends for use in new build as well as renovation of liner pools, marked as "N + S", only available with PVC weld strips.
- 2 step-ends as universal models for all pool types: liner, tile, metal, or fibreglass referred to as "U" (underwater).
- Installation material and instructions are always included in the deliveries.
- Technical shafts, manhole covers and panel pools.

Step-ends designed for New liner pools under construction ("N")

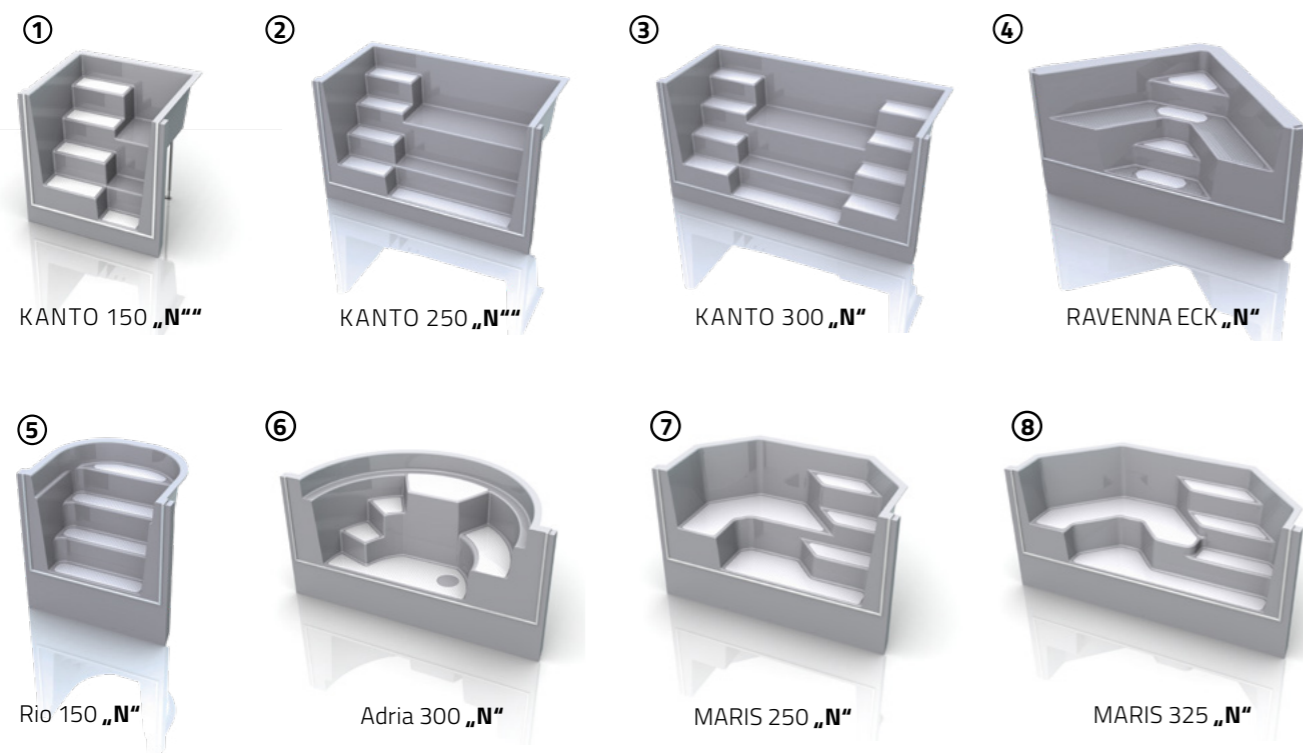

Step-ends with PVC strip to weld on a liner with 1,5 mm thickness

installation in pool corners, backfilling unnecessary

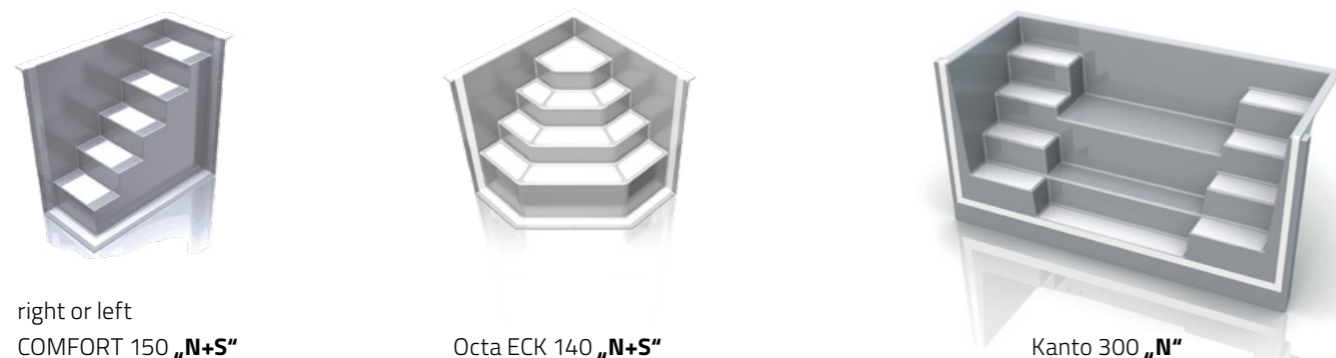

Retro-fit Step-ends installed in the pool - **UNIVERSAL**

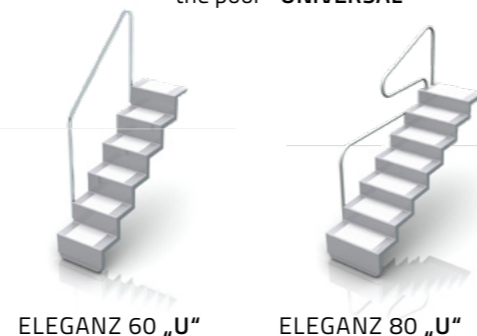

GRABRAILS ALL IN STAINLESS STEEL

Grabrails are the perfect equipment for a safe entry into the pool especially in combination with anti-slip profiled surface of the Reku steps (which are standard). Our grabrails are fixed on the pool deck or on the entry step.

The following grabrails for the Reku steps are available:

- ① Grabrail Marina small for all types of step-ends
- ② Universal grabrail "above water level" for all types of step-ends
- ③ Grabrail "below water level" for Eleganz 60 K + L or 80 K + L
- ④ Grabrail "small and big bow", one piece for Eleganz 60 K + L or 80 K + L

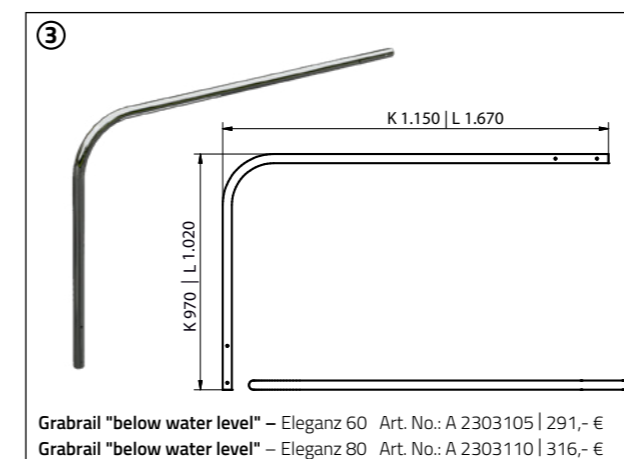
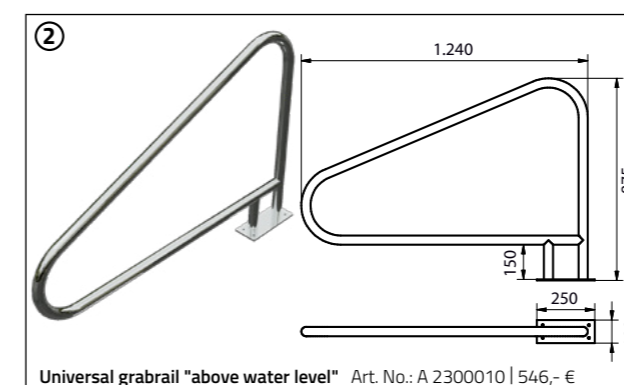
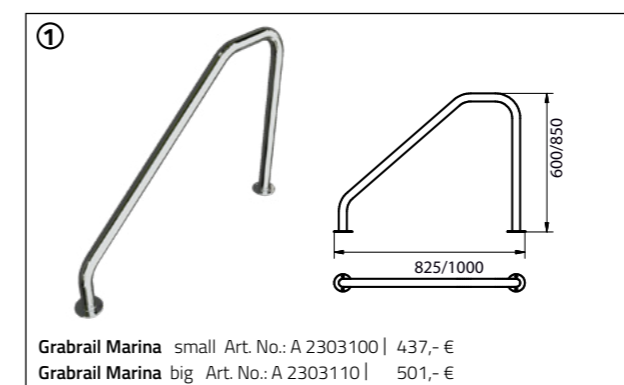

Attention: the width and depth of the step treads of the Eleganz 60 and Eleganz 80 are different; therefore the universal grabrails "below water level" and "small and big bow" have different dimensions.

The grabrails "above water level" and "below water level" are specially made for pools with floating covers. The universal grabrail "above water level" can as well be mounted on the first step of the Eleganz 60 or 80 L.

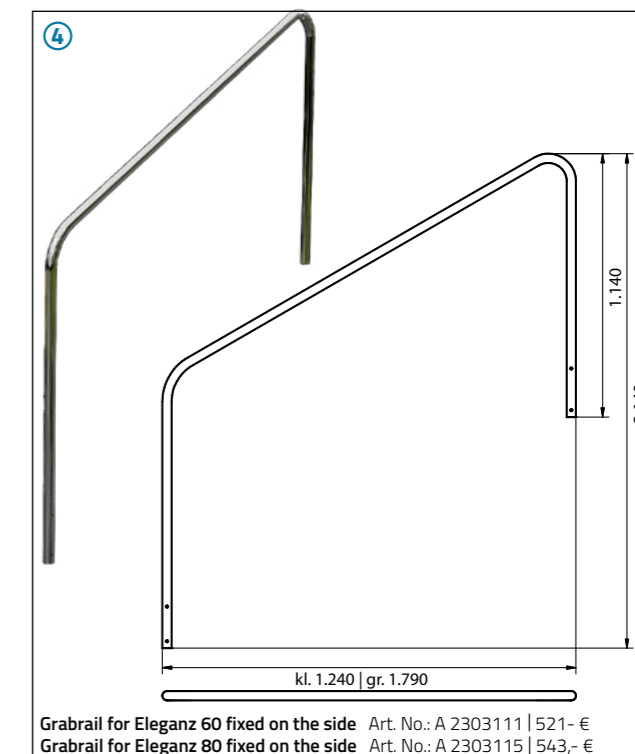

Examples for Use:

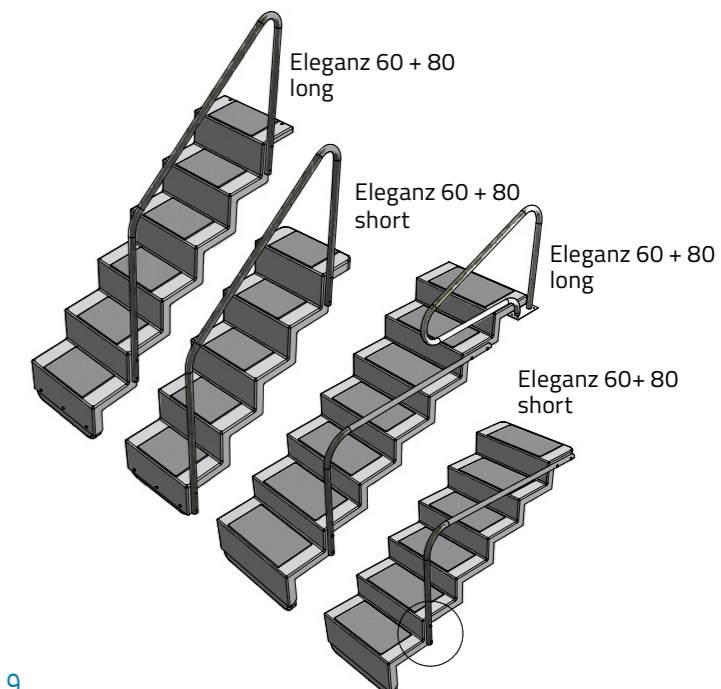

Step-ends for pools suitable for new construction or renovation („N+S“)

Stairs especially for 1.5 mm PVC liner from the roll, with PVC connection strip for welding or gluing!

The models OCTA ECK 140 and COMFORT 150 are only suitable for 1.5 mm PVC liner to be welded on. The steps are placed in corners and fixed with bolts. All transition joints filled with silicone. Please see the left picture below. An refit installation during renovation is possible.

The upper edge will be cutted to / under the coping stone. The corner will be sealed with silicone, PVC liner connection you can see picture left. A concrete backfill is not necessary. It is also possible to install both models in an existing pool.

A 20 cm wide strip of liner is welded on the PVC strip as well as on the existing liner. See the right picture below.

All 8 REKU step-end models for new constructions with a terminal strip are also available with a PVC weld-on strip, which is available at the same price.

Example: see Kanto 300 staircase on page 11.

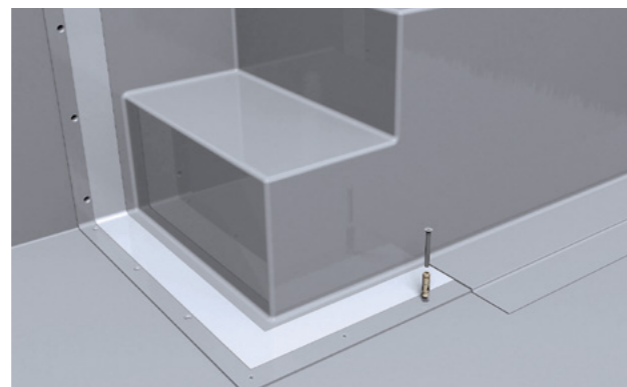
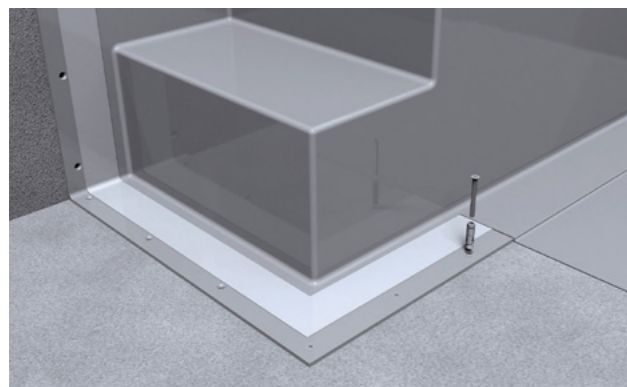

The edge plate runs straight through

COMFORT 150 „left+right“

Art.-No.: T Com150“N“ CL

PL (PVC-Strip)

Colour: White (03)	€ 1.874,-
Sea Blue (04) and Sand (13)	€ 1.968,-
Azure Blue (07), Silver grey (22), Granite (37)	€ 2.090,-
Steps in a contrasting colour	€ 162,-
Grabrail Marina, polished, per piece Art. No.: A 2303100	€ 437,-
Packed in a shrink film, one way pallet net P Com150 CL L/R	€ 29,-
Freight costs, per piece	on request
Delivery to the private customer is not possible	

All prices in Euro, excl. VAT

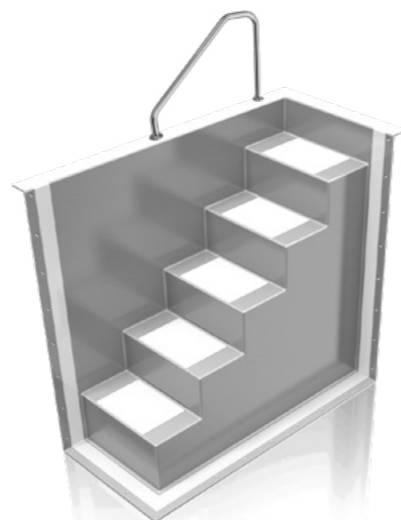

Dimensions L x b x d:
1.500 x 600 x 1.510 mm

Shipping weight: 98 kg

Recommendation for coping stones:
miter cut 45° on site

Installation in finished pool corner so without backfilling. Steps-end available in left and right versions (downwards direction). Please specify when ordering!

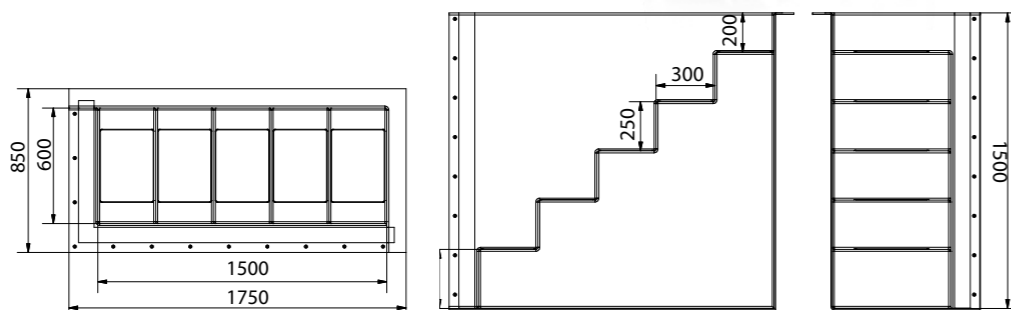

The coping stones passed through straight and should overlap by approx. 3 cm into the pool.

OCTA ECK 140 „S“

Art.-No.: T Oct140x140CL..

PL (PVC-Strip)

Colour: White (03)	€ 2.661,-
Sea Blue (04) and Sand (13)	€ 2.794,-
Azure Blue (07), Silver grey (22), Granite (37)	€ 2.967,-
Steps in a contrasting colour	€ 190,-
Grabrail Marina, polished, per piece Art. No.: A 2303100	€ 437,-
Packed in a shrink film, one way pallet net P Octa 140 CL	€ 32,-
Freight costs, per piece	on request
Delivery to the private customer is not possible	

Dimensions L x b x d:
1.400 x 1.400 x 1.510 mm

Recommendation for coping stones:
miter cut 45° on site

Shipping weight: 130 kg

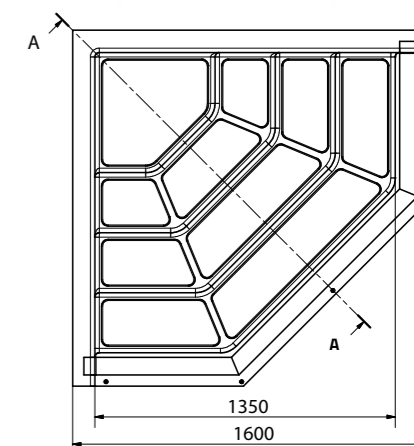
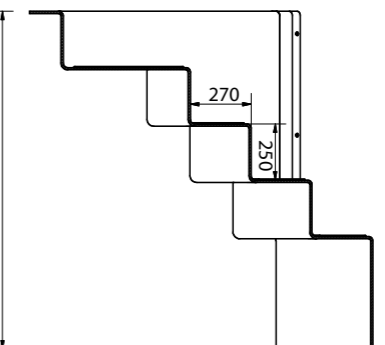
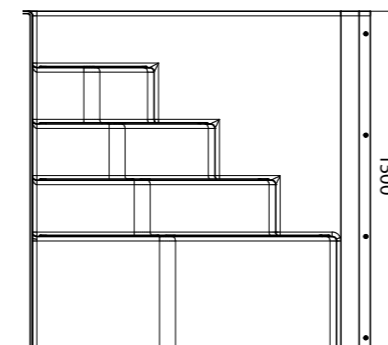

KANTO 300 „N“ 5 Steps

Art.-No.: T Kan300 “N“ CL...

PL (PVC-Strip)

Colour: White (03)	€ 3.865,-
Sea Blue (04) and Sand (13)	€ 4.058,-
Azure Blue (07), Silver grey (22), Granite (37)	€ 4.309,-
Steps in a contrasting colour	€ 217,-
Grabrail Marina, polished, per piece Art. No.: A 2303100	€ 437,-
Packed in a shrink film, one way pallet net P Kan300 CL	€ 41,-
Freight costs, per piece	on request
Delivery to the private customer is not possible	

All prices in Euro, excl. VAT

Dimensions L x B T:
1.165 x 3.000 x 1.500 mm

Shipping weight: 163 kg

5 steps plus sitting lounge.
Suitable for counter current installation.
Suitable for air channel system.

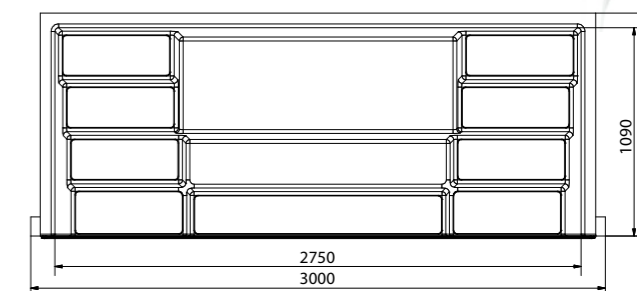
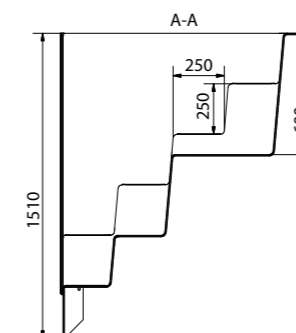

Step-ends particularly suitable for Universal installation ("U")

The following models ELEGANZ U 60 & 80 „U“ are designed for all pools, independent from pool construction They are placed in the water and can be used in existing

pools – for PVC -liner, concrete with tiles, metal or plastic. It can be used in existing pools as well.

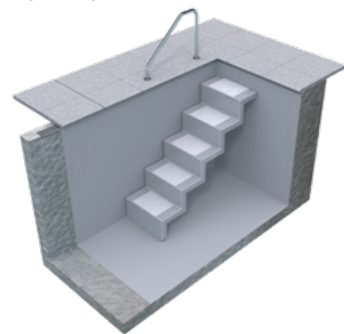

5 steps, short version, fixed with 2 bolts in the wall, with rubber plates on the floor.

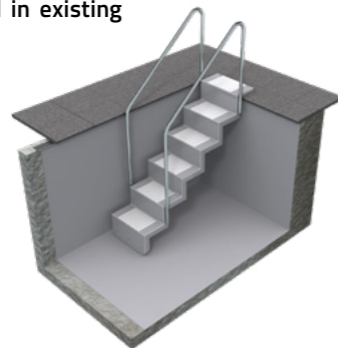

5 steps, long version, fixed with 2 bolts in the coping stone. Rubber base plate on the floor without fixings.

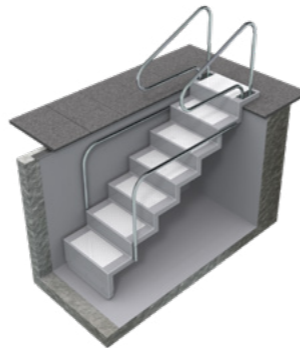

The Eleganz L can be delivered with a grabrail on the right and / or on the left hand side.

All Steps have built in weghts that prevent the steps from floating. Fixing and instructions are included.



6 steps, short version, fixed with 2 bolts in the wall, without fixings on the floor.

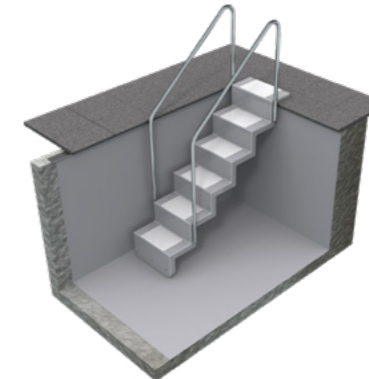

6 steps, long version, fixed with 2 bolts in the coping stone. without fixings on the floor.

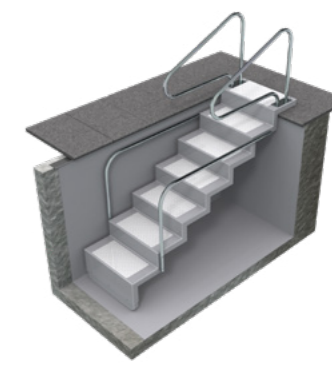

The Eleganz L can be delivered with a grabrail on the right and / or on the left hand side.

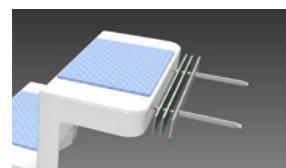

Fixation with wall anchors V4A for for Eleganz 60 + 80 K (short version)

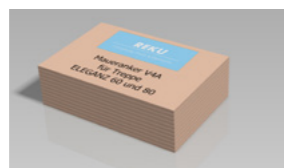

Adjustable foot with deflector for vacuum cleaner

Adjustable foot to adapt the step to the depth of the pool.
Eleganz L: 1540-1700 mm
Eleganz K 1390-1430 mm
Special dimensions are available upon request for both types.

ELEGANZ 60 „U“

	Art.- No.: Ele60 "U" CL..	K (Version "short")	L (Version "long")
Colour: White (03)		€ 1.306,-	€ 1.520,-
Sea Blue (04), Sand (13)		€ 1.371,-	€ 1.596,-
Azure Blue (07), Silver grey (22), Granite (37)		€ 1.456,-	€ 1.695,-
Steps in a contrasting colour		€ 162,-	€ 162,-
Wall anchor for Eleganz 60 + 80 K (short version)	Art. No.: Z Kon022 Eis	€ 98,-	-
Grabrail Marina, polished, per piece	Art. No.: A 2303100	€ 437,-	€ 437,-
Grabrail Eleganz of round tube, fixed on the side, polished, per pc	Art. No.: A 2303111	€ 521,-	€ 521,-
Universal grabrail "above water level" polished, per pc	Art. No.: A 2300010	€ 546,-	€ 546,-
Grabrail "below water level" Eleganz 60 fixed on the side, polished, per pc	Art. No.: A 2303105	€ 291,-	€ 291,-
Packed in a carton on one way pallet	Art. No.: Pak Ele060CL	€ 28,-	€ 28,-
Freight costs, per piece		on request	on request
Freight costs, 6 pieces on pallet		on request	on request

Delivery to private customer is possible!

Special version Eleganz 60 L + K for pools with depth 1,25 (1,20 - 1,30) Meter at the same price available! All prices in Euro, excl. VAT

Dimensions B x d: 600 x 1.300 mm
Shipping weight: 65 kg

Dimensions b x d: 600 x 1.580 mm
Shipping weight: 80 kg

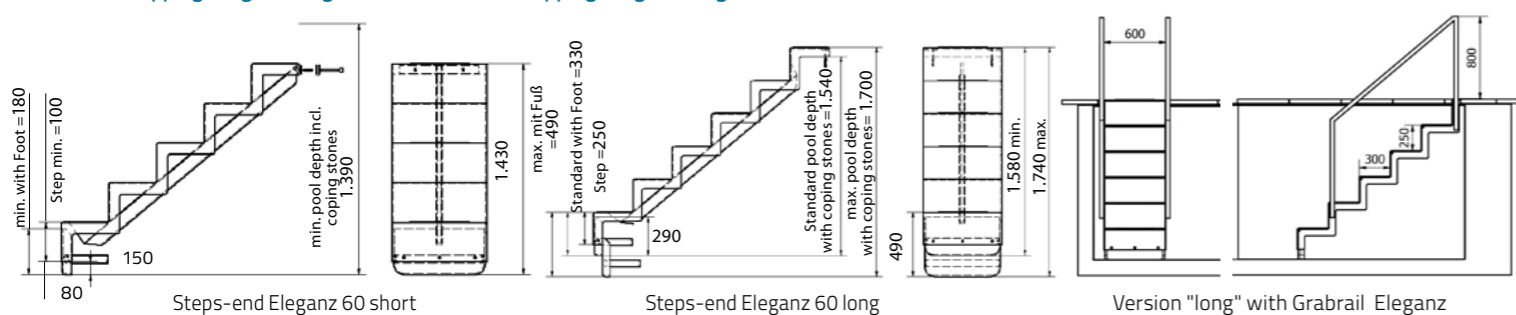

ELEGANZ 80 „U“

	Art.- No.: Ele80 "U" CL..	K (Version "short")	L (Version "long")
Colour: White (03)		€ 1.960,-	€ 2.280,-
Sea Blue (04), Sand (13)		€ 2.058,-	€ 2.394,-
Azure Blue (07), Silver grey (22), Granite (37)		€ 2.185,-	€ 2.542,-
Steps in a contrasting colour		€ 162,-	€ 162,-
Wall anchor for Eleganz 60 + 80 K (short version)	Art. No.: Z Kon022 Eis	€ 98,-	-
Grabrail Marina, polished, per piece	Art. No.: A 2303100	€ 437,-	€ 437,-
Grabrail Eleganz of round tube, fixed on the side, polished, per pc	Art. No.: A 2303115	€ 543,-	€ 543,-
Universal grabrail "above water level" polished, per pc,	Art. No.: A 2300010	€ 546,-	€ 546,-
Grabrail "below water level" Eleganz 80 fixed on the side, polished, per pc	Art. No.: A 2303110	€ 316,-	€ 316,-
Packed in a carton on one way pallet	Art. No.: Pak Ele080CL	€ 33,-	€ 33,-
Freight costs, per piece		on request	on request
Freight costs, 3 pieces on pallet		on request	on request

Delivery to private customer is possible!

All prices in Euro, excl. VAT

Dimensions b x d: 800 x 1.300 mm
Shipping weight: 95 kg

Dimensions b x d: 800 x 1.580 mm
Shipping weight: 117 kg

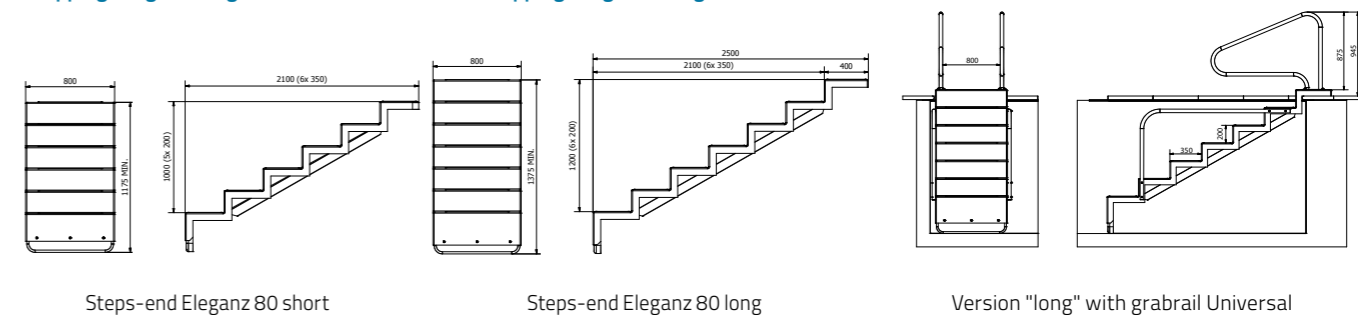

Step-ends on pages 14-17 have to be installed between the pool walls and then to be levelled from behind and backfilled with concrete.

KANTO 150 „N“ 5 Steps

Art-Nr. T Kan150 "N" CL.. KL (clamp plate)
T Kan150 "N" CL.. PL (PVC-Strip)

Colour: White (03)	€ 2.196,-
Sea Blue (04) and Sand (13)	€ 2.306,-
Azure Blue (07), Silver grey (22), Granite (37)	€ 2.449,-
Steps in a contrasting colour	€ 145,-
Grabrail Marina, polished, per piece Art. No.: A 2303100	€ 437,-
Packed in a shrink film, one way pallet net P Kan150 CL	€ 24,-
Freight costs, per piece	on request
Delivery to the private customer is not possible	

All prices in Euro, excl. VAT

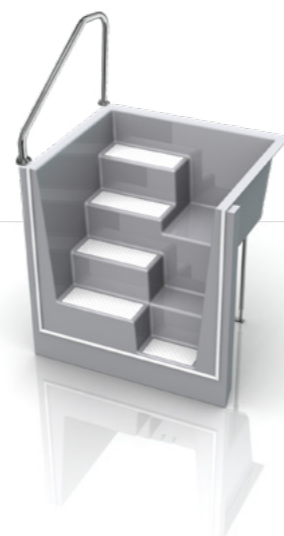

Dimensions L x b x d:
1.165 x 1.500 x 1.500 mm

Shipping weight: 86 kg

5 steps plus sitting lounge.
Suitable for counter current installation.
Suitable for air channel system.

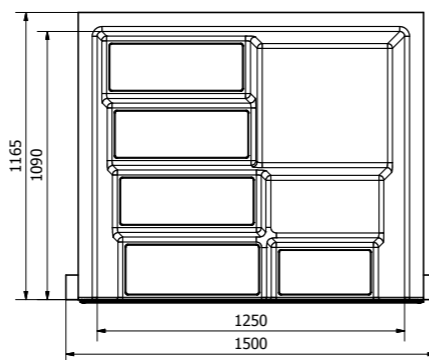
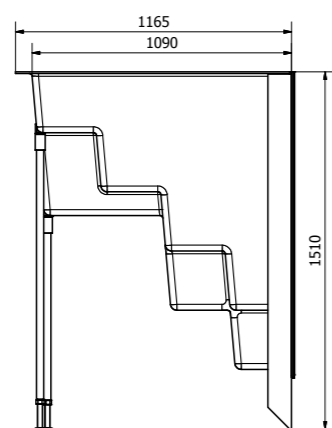

KANTO 250 „N“ 5 Steps

Art-Nr. T Kan250 "N" CL.. KL (clamp plate)
T Kan250 "N" CL.. PL (PVC-Strip)

Colour: White (03)	€ 2.898,-
Sea Blue (04) and Sand (13)	€ 3.043,-
Azure Blue (07), Silver grey (22), Granite (37)	€ 3.231,-
Steps in a contrasting colour	€ 145,-
Grabrail Marina, polished, per piece Art. No.: A 2303100	€ 437,-
Packed in a shrink film, one way pallet net P Kan250 CL	€ 32,-
Freight costs, per piece	on request
Delivery to the private customer is not possible	

All prices in Euro, excl. VAT



Dimensions L x b x d:
1.165 x 2.500 x 1.500 mm

Shipping weight: 140 kg

5 steps plus sitting lounge.
Suitable for counter current installation.
Suitable for air channel system.

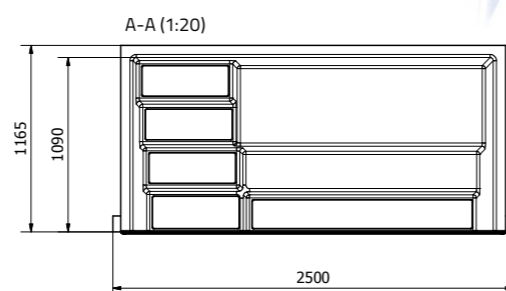
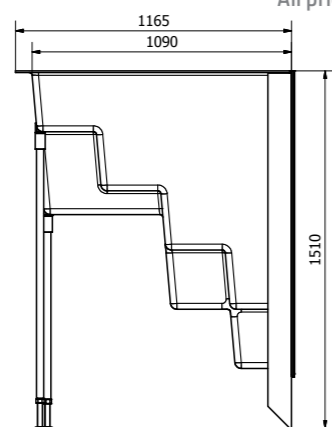

The steps can be supplied with liner lock fixing plates or PVC welding strip for 1.5 mm liners. Please specify when ordering! Mounting material is included!

KANTO 300 „N“ 5 Steps

Art-Nr. T Kan300 "N" CL.. KL (clamp plate)
T Kan300 "N" CL.. PL (PVC-Strip)

Colour: White (03)	€ 3.865,-
Sea Blue (04) and Sand (13)	€ 4.058,-
Azure Blue (07), Silver grey (22), Granite (37)	€ 4.309,-
Steps in a contrasting colour	€ 217,-
Grabrail Marina, polished, per piece Art. No.: A 2303100	€ 437,-
Packed in a shrink film, one way pallet net P Kan300 CL	€ 41,-
Freight costs, per piece	on request
Delivery to the private customer is not possible	

All prices in Euro, excl. VAT

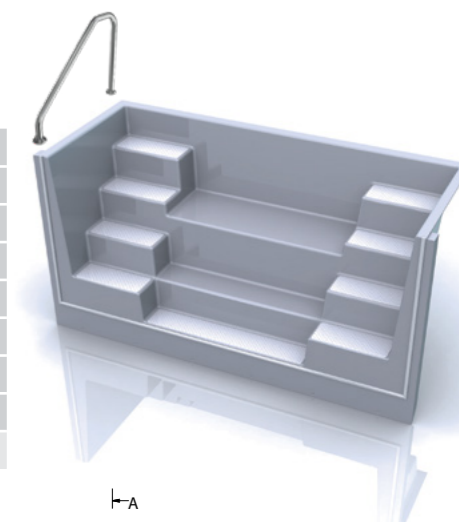

Dimensions L x B T:
1.165 x 3.000 x 1.500 mm

Shipping weight: 163 kg

5 steps plus sitting lounge.
Suitable for counter current installation.
Suitable for air channel system.

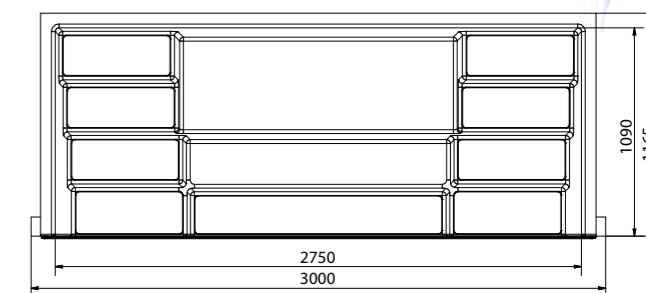
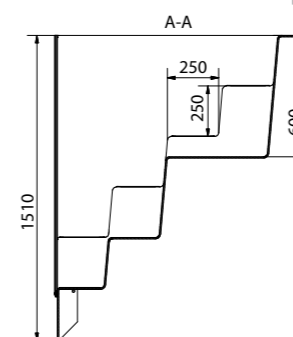

RAVENNA ECK 200 x 200

Art-Nr. T Rav200x200"N"CL.. KL (clamp plate)
T Rav200x200 "N"CL.. PL (PVC-Strip)

Colour: White (03)	€ 3.158,-
Sea Blue (04) and Sand (13)	€ 3.316,-
Azure Blue (07), Silver grey (22), Granite (37)	€ 3.521,-
Steps in a contrasting colour	€ 136,-
Handrail Universal Upper part, per piece Art. No.: A 2300010	€ 546,-
Packed in a shrink film, one way pallet net P Rav2x2 CL	€ 66,-
Freight costs, per piece	on request
Delivery to the private customer is not possible	

All prices in Euro, excl. VAT

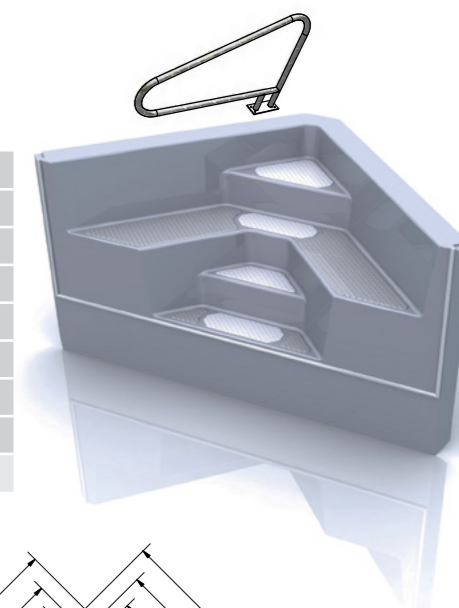

Dimensions L x B T:
2.000 x 2.000 x 1.510 mm

Shipping weight: 140 kg

Recommendation for coping stones:
Straight stones, flat on the stairs

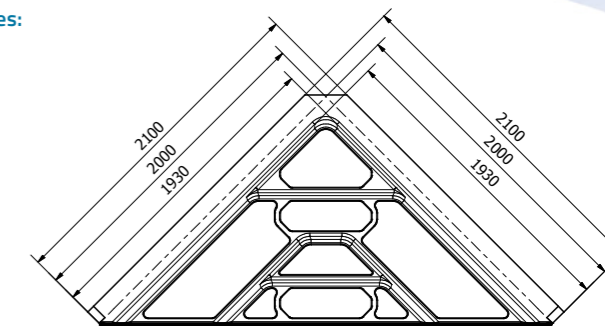
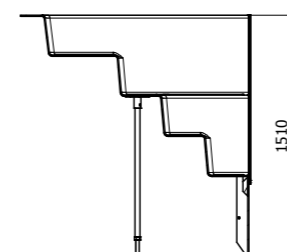

The steps can be supplied with liner lock fixing plates or PVC welding strip for 1.5 mm liners. Please specify when ordering. Mounting material is included

RIO 150 „N“ 5 Steps

Art.-No.: T Rio150 "N" CL.. KL (clamp plate)
T Rio150 "N"CL.. PL (PVC-Strip)

Colour: White (03)	€ 1.946,-
Sea Blue (04), Sand (13)	€ 2.043,-
Azure Blue (07), Silver grey (22), Granite (37)	€ 2.170,-
Steps in a contrasting colour	€ 159,-
Grabrail for RIO 150 left/right, polished, per piece	Art. No.: A 2322030 € 569,-
Packed in a shrink film, one way pallet net	€ 18,-
Freight costs, per piece	on request
Delivery to the private customer is not possible	

All prices in Euro, excl. VAT

Dimensions L x b x d:
1.075 x 1.500 x 1.510 mm

Shipping weight: 86 kg

Recommendation for coping stones:
2 pieces, Radius 500 mm with straight cut stone

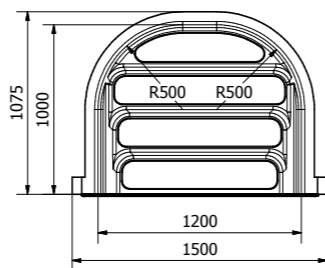
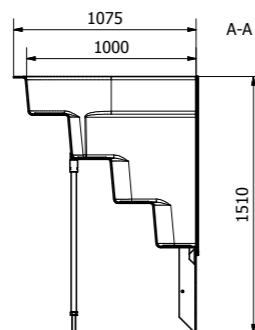

ADRIA 300 „N“

Art.-No.: T Adr300CL.. KL (clamp plate)
T Adr300CL.. PL (PVC-Strip)

Colour: White (03)	€ 3.630,-
Sea Blue (04) and Sand (13)	€ 3.812,-
Azure Blue (07), Silver grey (22), Granite (37)	€ 4.047,-
Steps in a contrasting colour	€ 216,-
Grabrail for MALAGA 325 right, polished, per piece	Art. No.: A 2302010 € 580,-
Packed in a shrink film, one way pallet net	€ 66,-
Freight costs, per piece	on request
Delivery to the private customer is not possible	

All prices in Euro, excl. VAT

Dimensions L x b x d:
1.250 x 3.000 x 1.510 mm

Recommendation for coping stones:
Radius 1.250 mm

Shipping weight: 185 kg

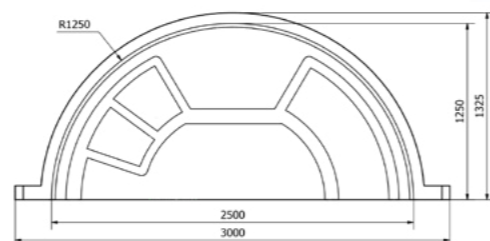
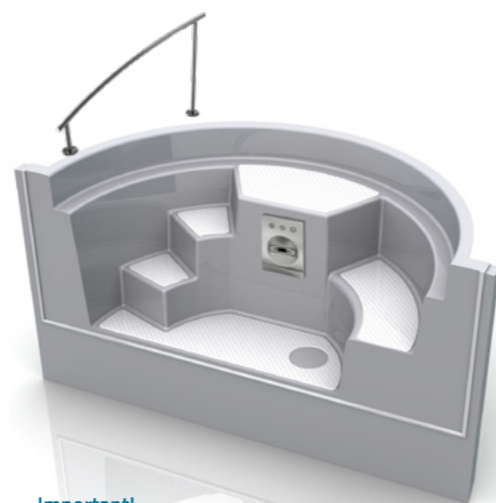
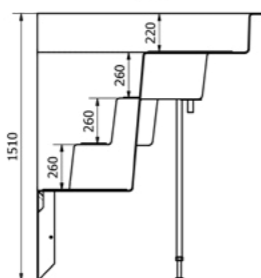

Important!
Suitable for counter current installation.
Suitable for air channel system.
The place under sitting lounge suitable for inlet jet as foot massage!

The steps can be supplied with liner lock fixing plates or PVC welding strip for 1.5 mm liners. Please specify when ordering. Mounting material is included!

MARIS 250 „N“

Art.-No.: T Mar250 CL.. KL (clamp plate)
T Mar250 CL.. PL (PVC-Strip)

Colour: White (03)	€ 2.693,-
Sea Blue (04) and Sand (13)	€ 2.828,-
Azure Blue (07), Silver grey (22), Granite (37)	€ 3.003,-
Steps in a contrasting colour	€ 190,-
Grabrail Marina, polished, per piece	Art. No.: A 2303100 € 437,-
Packed in a shrink film, one way pallet net	P Mar250 CL € 32,-
Freight costs, per piece	on request
Delivery to the private customer is not possible	

All prices in Euro, excl. VAT

Dimensions L x B T:
1080 x 2500 x 1500 mm

Shipping weight: 111 kg

Recommendation for coping stones:
miter cut 45° on site

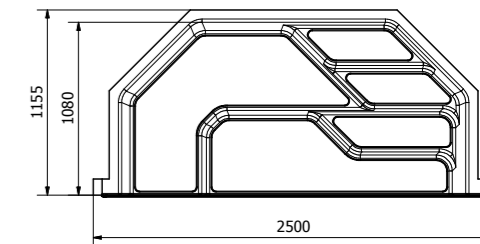
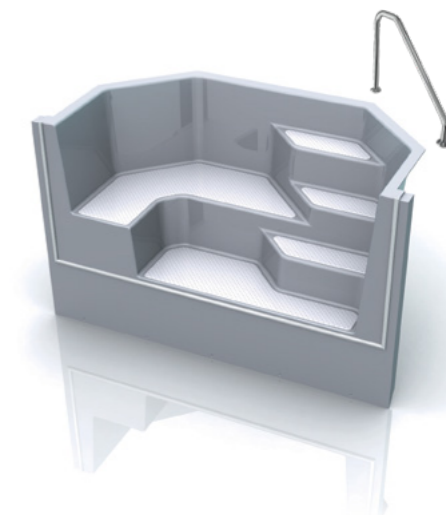
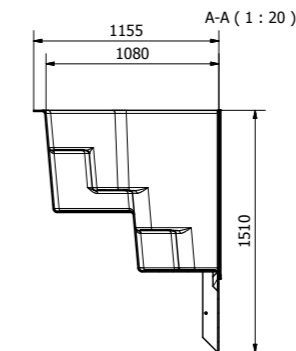

MARIS 325 „N“

Art.-No.: T Mar325 CL.. KL (clamp plate)
T Mar325 CL.. PL (PVC-Strip)

Colour: White (03)	€ 3.821,-
Sea Blue (04) and Sand (13)	€ 4.012,-
Azure Blue (07), Silver grey (22), Granite (37)	€ 4.260,-
Steps in a contrasting colour	€ 216,-
Grabrail Marina, polished, per piece	Art. No.: A 2303100 € 437,-
Packed in a shrink film, one way pallet net	P Mar325 CL € 66,-
Freight costs, per piece	on request
Delivery to the private customer is not possible	

All prices in Euro, excl. VAT

Dimensions L x b x d:
1.180 x 3.250 x 1.510 mm

Shipping weight: 160 kg

Recommendation for coping stones:
miter cut 45° on site

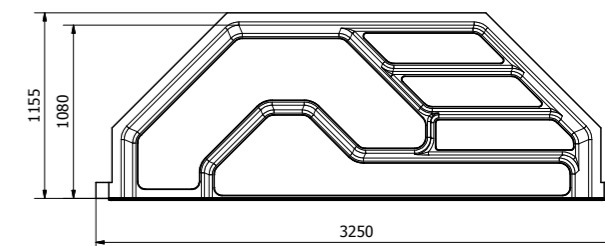
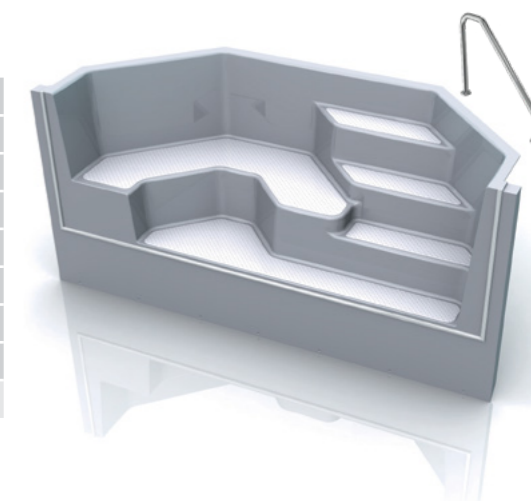
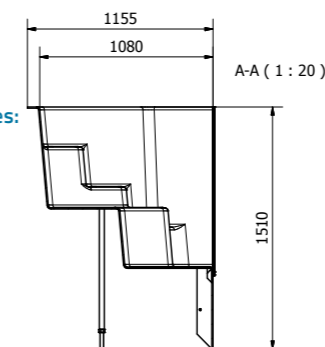

The steps can be supplied with liner lock fixing plates or PVC welding strip for 1.5 mm liners. Please specify when ordering. Mounting material is included!

TECHNICAL SHAFTS* extension shaft for counter swim units & „Universal“

* not for pool stairs, only for installation in styrofoam pools

Technical shaft:

'- for counter swim units

Suitable for the styrofoam pool, with drip water drainage below, 2 adjusting supports for screwing onto the concrete slab. Built-in fan for ventilation controlled by a hygrostat.

External dimensions (l x b x d):

Price per Piece		
1.050 x 800 x 751 mm	K TS720GSA1050 GW 03 K	820,-
1.250 x 800 x 751 mm	K TS720GSA1250 GW 03 K	1.070,-
1.050 x 800 x 751 mm	K TS720GSA1500 GW 03 K	1.320,-

In order to be able to securely attach the plates to the housing, plastic latches are supplied, these are attached at a distance of 25 cm and can be removed if necessary. A plastic plate is hung over the pump to prevent the water from dripping through.



TECHNICAL SHAFT „UNIVERSAL“

Suitable for straight pool walls either concrete, styrene, metal etc. open at the bottom.
 - Built-in ventilation with fan and hygrostat.
 - Height of the cover can be adjusted to match the slab or wood covering all around.

Dimensions: 1,7 x 1,7 x 1,5 m
Manhole: 1.245 x 765 mm
 Price per Piece: € 3.096,-

Surcharge cover, available in all step-ends colours
 (Please specify desired colour when ordering)
 Price per Piece: € 106,-

Surcharge for version "shower tray"
 Price per Piece: € 114,-



COVER VERSIONS

(lid type 1, 2 or 3, please specify when ordering)

- 1 Visible cover with anti-slip coating. The covering has a slip-proof certificate for wet areas (can be opened with 2 gas pressure dampers, 2 handles).
- 2 Same cover as item 1. without anti-slip covering for wood covering on site..
- 3 Lid as shower tray with anti-slip covering including waste set with 2 gas pressure dampers and 2 handles.

TECHNICAL SHAFTS

Installation wall with integrated technique shaft for counter-current systems

Built-in wall with integrated technology shaft in which counter-current system or underwater floodlights can be installed. Technology manholes are equipped with air vents, as well as with a drip water outlet. Suitable for installation in the straight pool walls, concrete, styrofoam, metal, etc., 2 adjusting supports for screwing onto the concrete slab. The lower part of the mounting wall can be shortened in the factory and so this part can be used as a closed technology shaft for the earth installation, away from the pool.

If desired, please specify when ordering!

Dimensions: - Wall 1000 mm wide, 1500 mm height, to be cutted up to 1200 mm
 - Depth of technique shaft is 700 mm

Dimension of manhole cover: 765 x 745 mm

Price per Piece: € 1.074,-

Surcharge for Cover available in all step-end colours

(lid in colour papyrus, please specify colour when ordering)

Price per Piece: € 95,-

Surcharge for version "shower tray"

Price per Piece: € 99,-

Film packaging with wooden pallet

Price per Piece: € 53,-



REKU - GRP - SKIMMER

REKU - GRP - Skimmer for swimming pools with PVC - lining 0,6 - 0,8 - 1,5 mm, with terminal strip including mounting accessories and picture - mounting instructions.

1. Water level from minus 15-8 cm variable through sliding standpipe as overflow
2. Edge plates cover the top and front continuously
3. Skimmer cover made of GRP can be shortened to adapt the plating
4. Skimmer weir accessible from above for service and replacement
5. Skimmer basket (+1 reserve) made of PVC with carrying handle
6. Colour white or silver grey; colour terminal strips like stairs
7. Suction opening large 42 cm
8. Wooden installation templates are supplied
9. Level controller mechanical Geberit installed in slosh-free cell. Optional on-site level controller can be installed.

Price per Piece: € 861,-

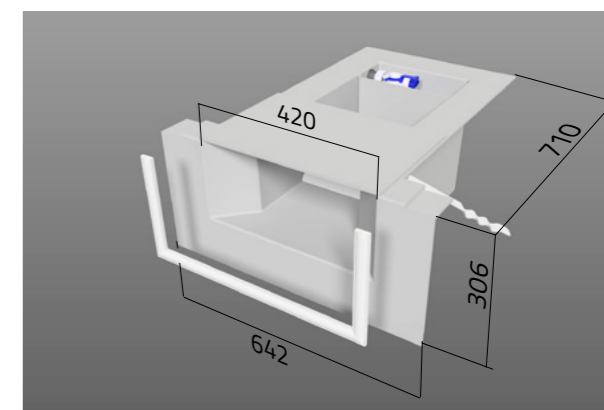



PREFAB POOLS

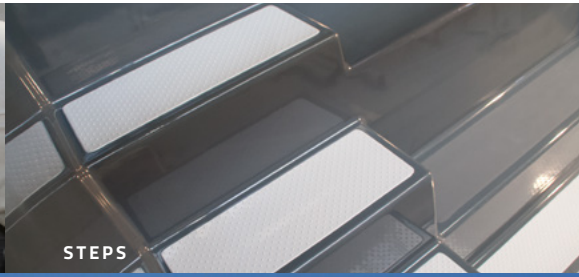

STEPS

FROM A GOOD FAMILY



Valid from 01.01.2021–31.12.2021 | Stand: 01.01.2021

www.reku.sk

REKU



Composite-Pools & Elements

REKU - Slovakia spol. s r. o. ■ Priemyselná 10/A ■ SK-917 01 Trnava, Slovakia ■ Tel.: +421 33 551 20 33, +421 33 591 39 11
E-Mail: info@reku.sk ■ vertrieb@reku.sk ■ www.reku.sk

REKU COMPOSITE-POOLS & ELEMENTS IST EIN UNTERNEHMEN DER **RivieraPool®**-GRUPPE